

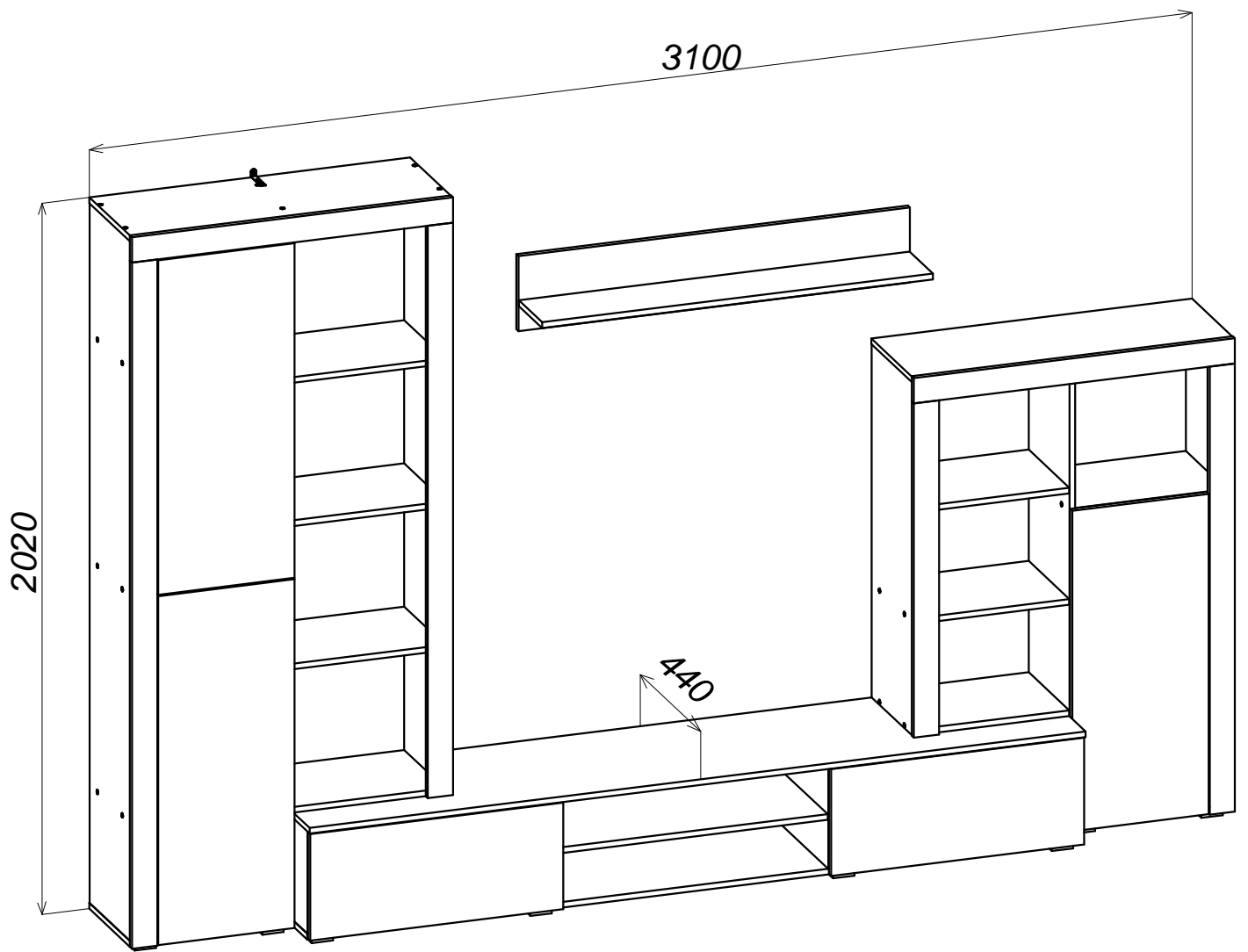

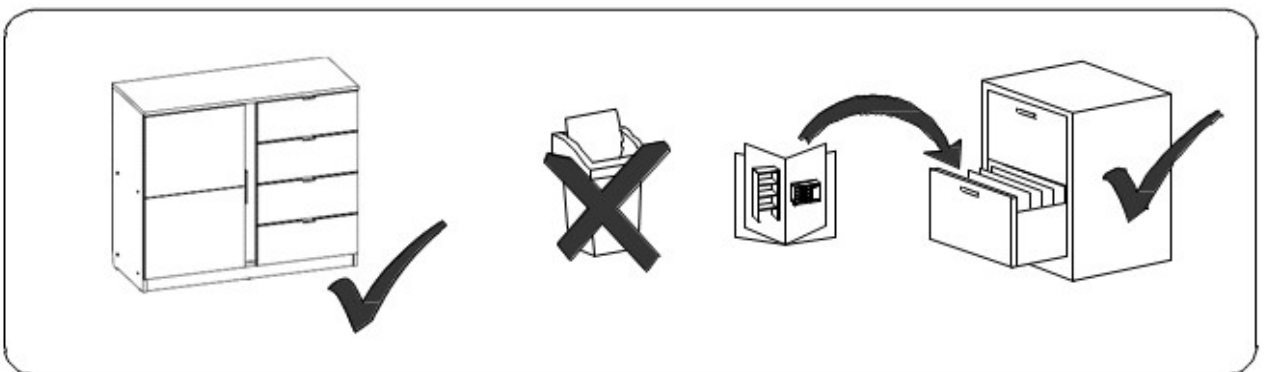

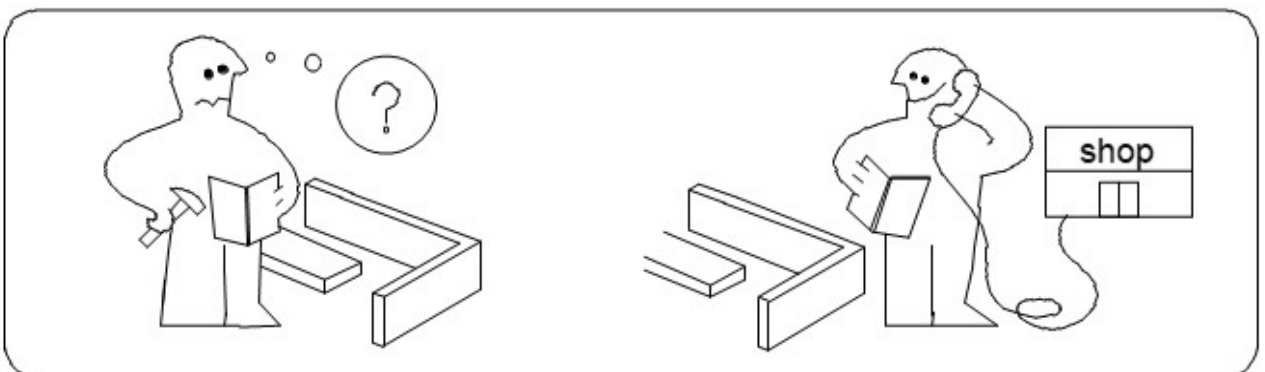

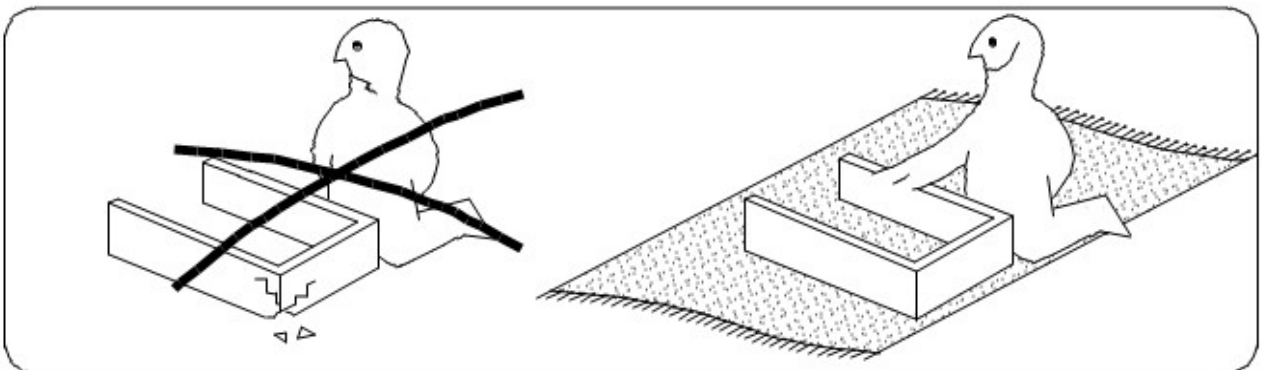

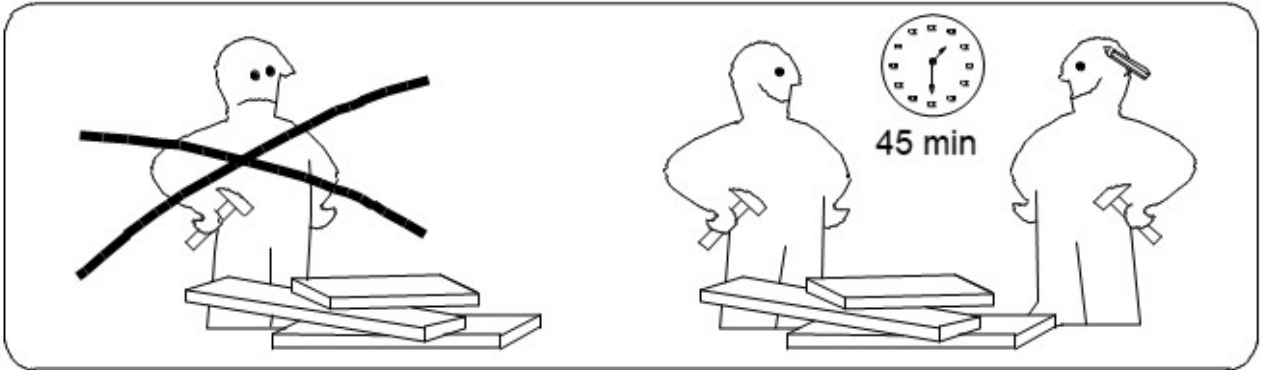
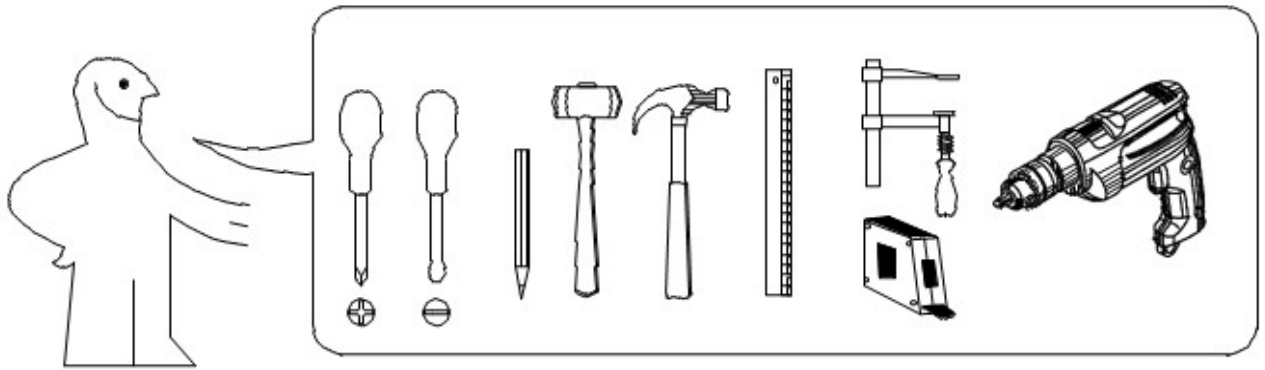
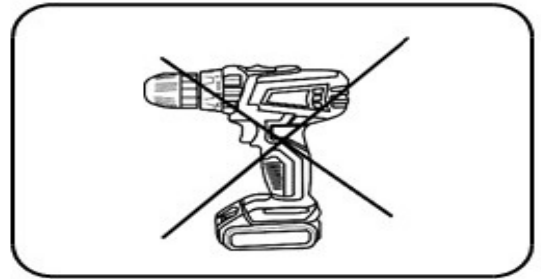
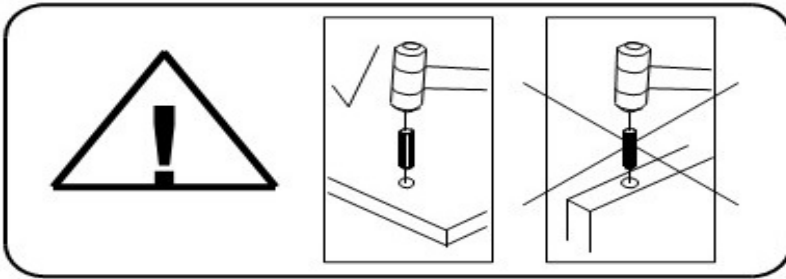













# Секция Пиеро







|   |  |   |  |   |
|---|--|---|--|---|
| <br>$\varnothing 6,3 \times 50 \text{ mm}$<br><b>A1 x 65</b>   | <br>$\varnothing 12 \text{ mm}$<br><b>A2 x 65</b>           | <br>4 mm<br><b>A3 x 1</b>                                  | <br>$\varnothing 15 \times 12 \text{ mm}$<br><b>B1 x 38</b> | <br>$\varnothing 5 \times 44 \text{ mm}$<br><b>B2 x 38</b> |
| <br>$\varnothing 20 \text{ mm}$<br><b>B3 x 38</b>              | <br>19x14 mm<br><b>C x 15</b>                               | <br>$\varnothing 4 \times 16 \text{ mm}$<br><b>D1 x 56</b> | <br>$\varnothing 3 \times 16 \text{ mm}$<br><b>D2 x 22</b>  | <br>$\varnothing 3 \times 25 \text{ mm}$<br><b>D3 x 15</b> |
| <br>$\varnothing 1,6 \times 25 \text{ mm}$<br><b>F x 186</b> | <br>$\varnothing 8 \times 36 \text{ mm}$<br><b>G x 31</b> | <br><b>L x 32</b>  | <br><b>M1 x 4</b>  | <br><b>M2 x 6</b>  |
| <br>h 20 mm<br><b>N x 17</b>                                 | <br>$\varnothing 8 \times 30 \text{ mm}$<br><b>T x 2</b>  | <br><b>U x 3</b>   | <br><b>V x 5</b>   | <br><b>X x 2</b>   |
| <br><b>Y x 2</b>   |  |   |  |   |
|   |  |   |  |   |

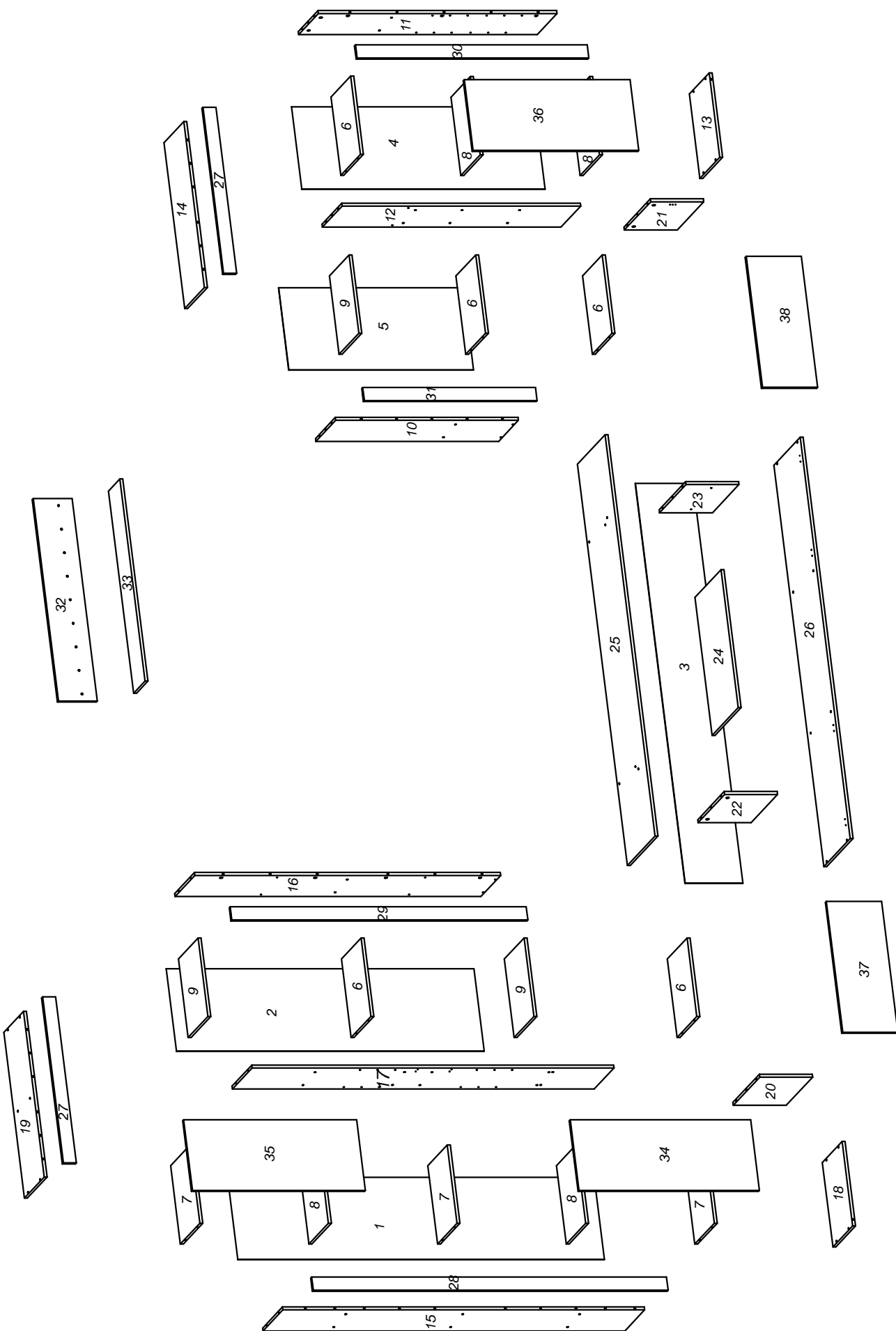

# Box 1 / 6

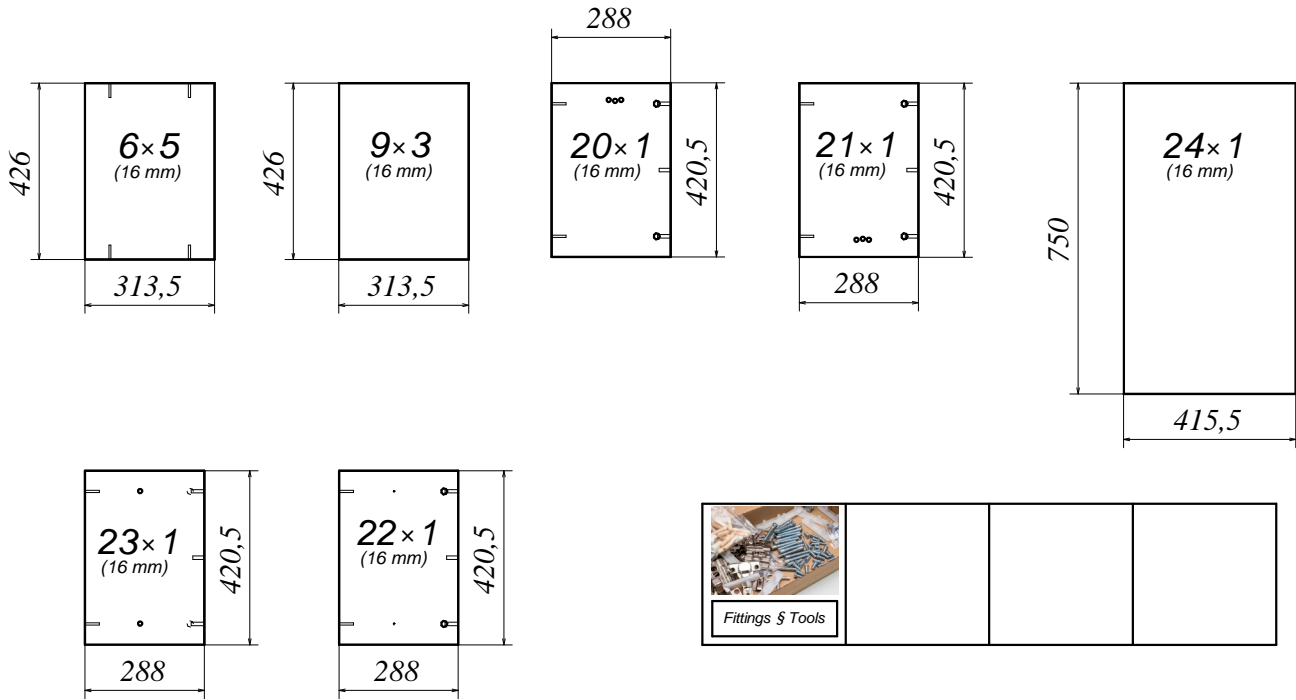

# Box 2 / 6

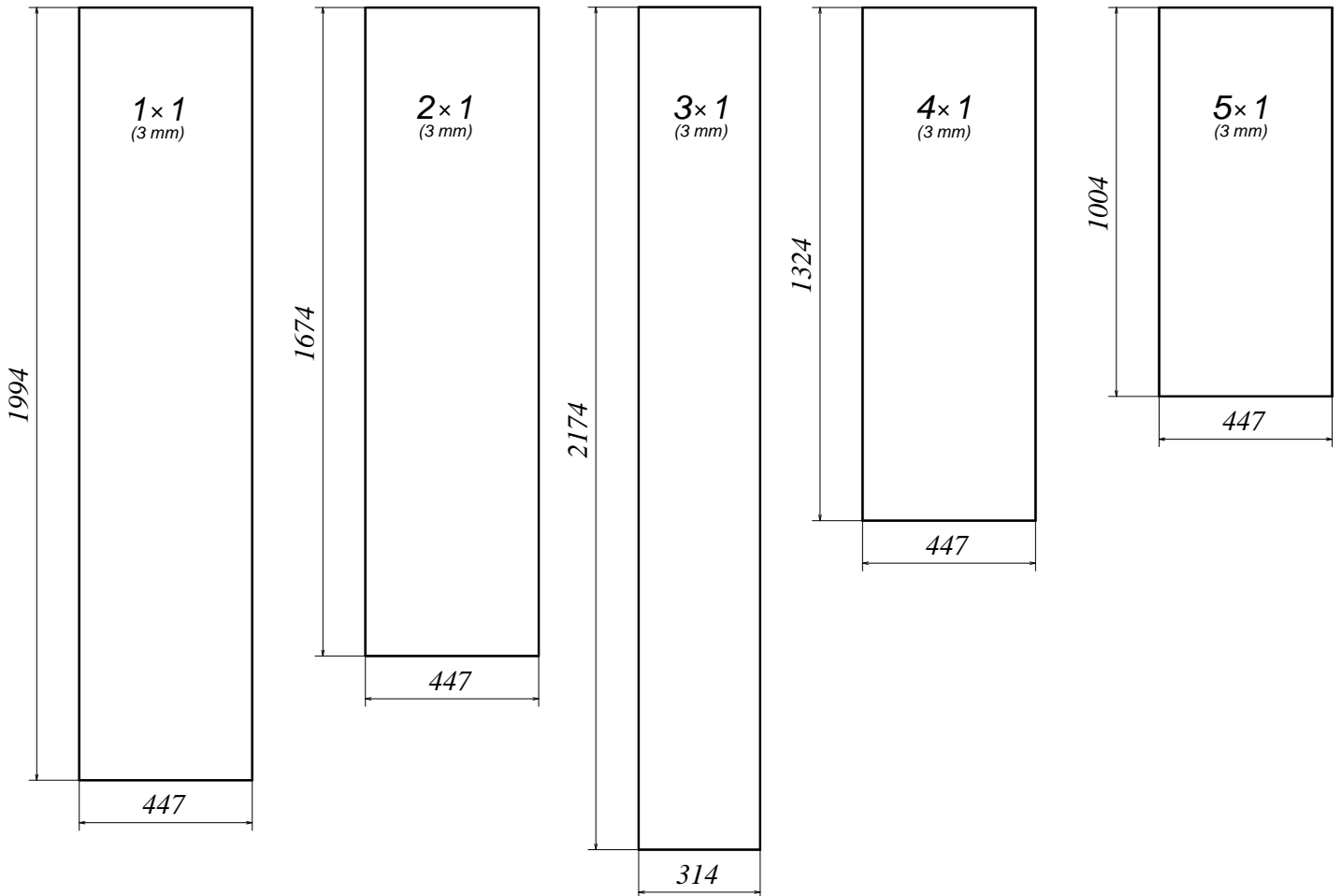

# Box 2 / 6

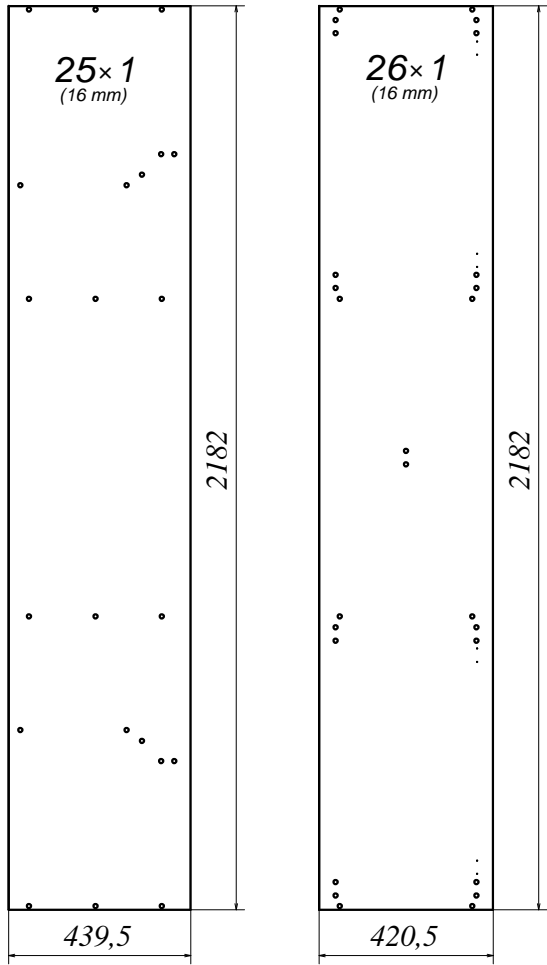

# Box 3 / 6

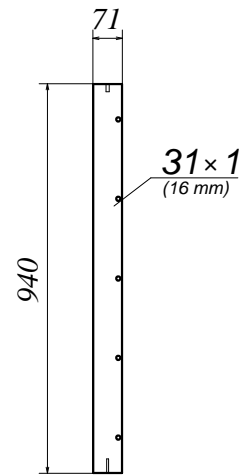
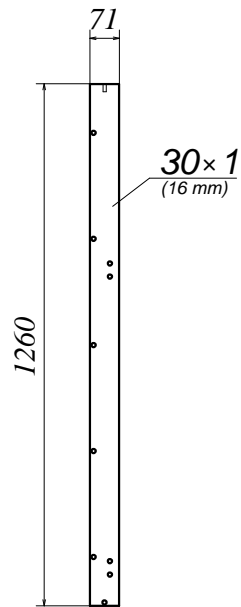
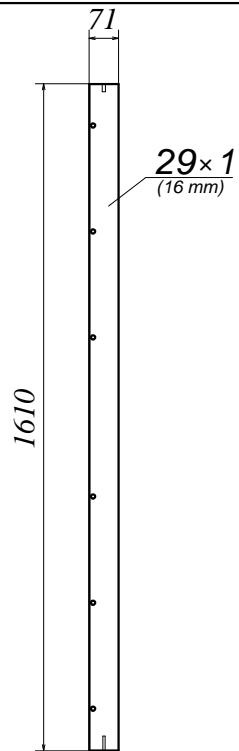
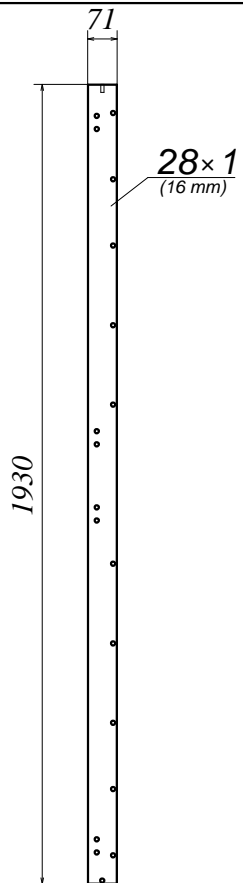
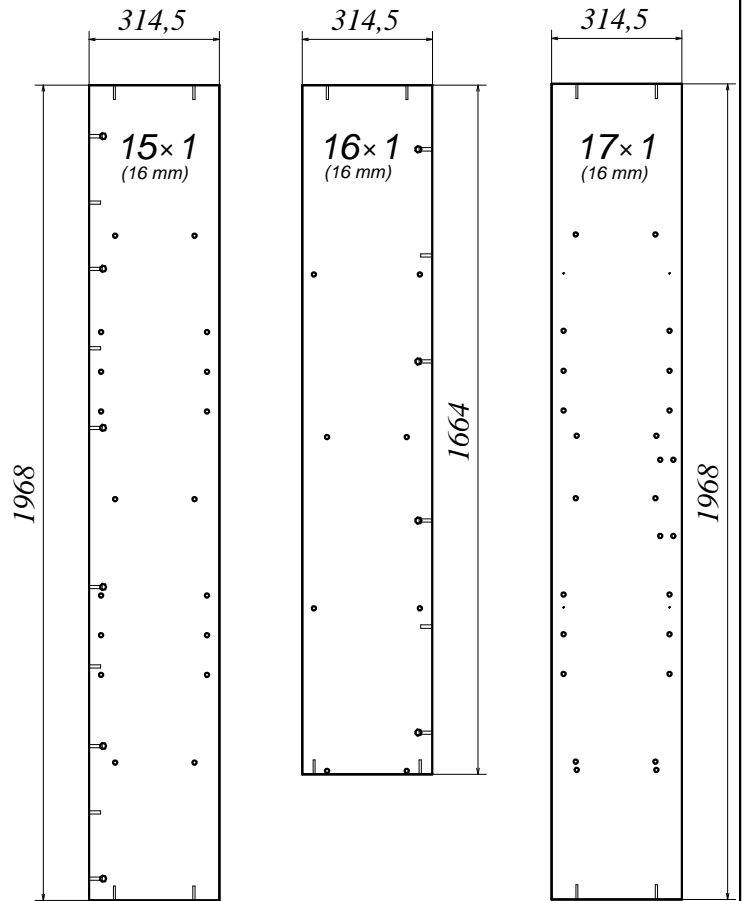

# Box 4 / 6

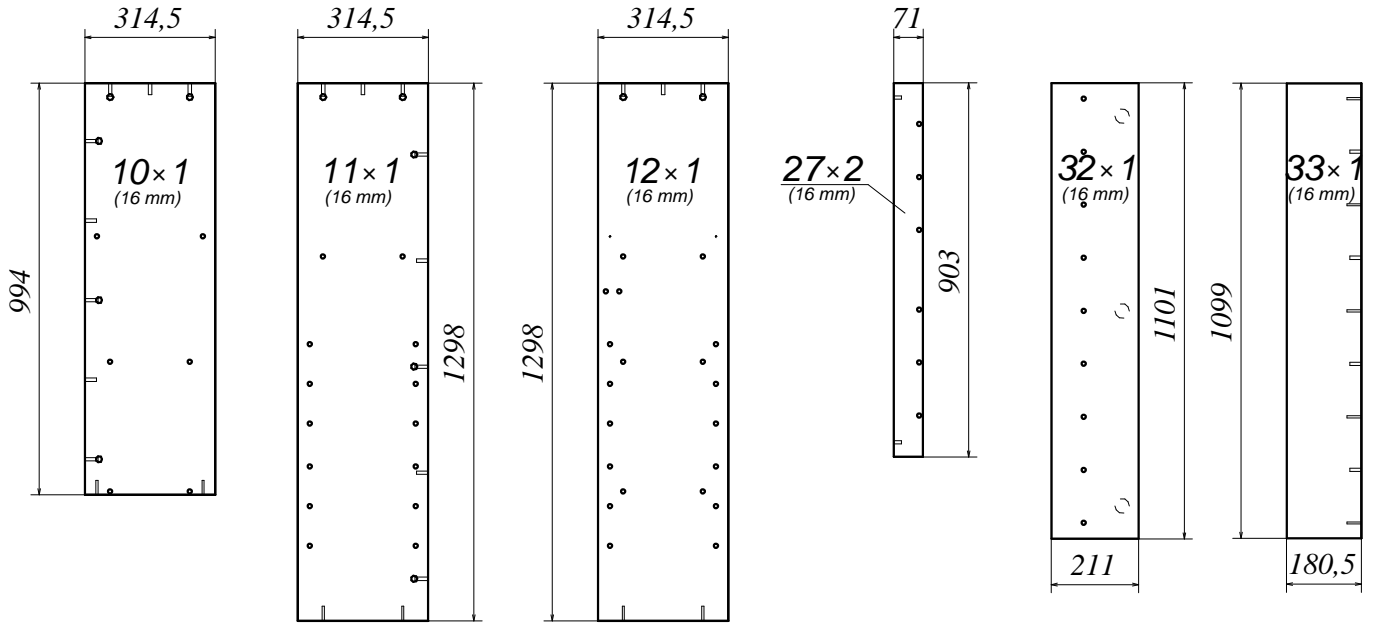

# Box 5 / 6

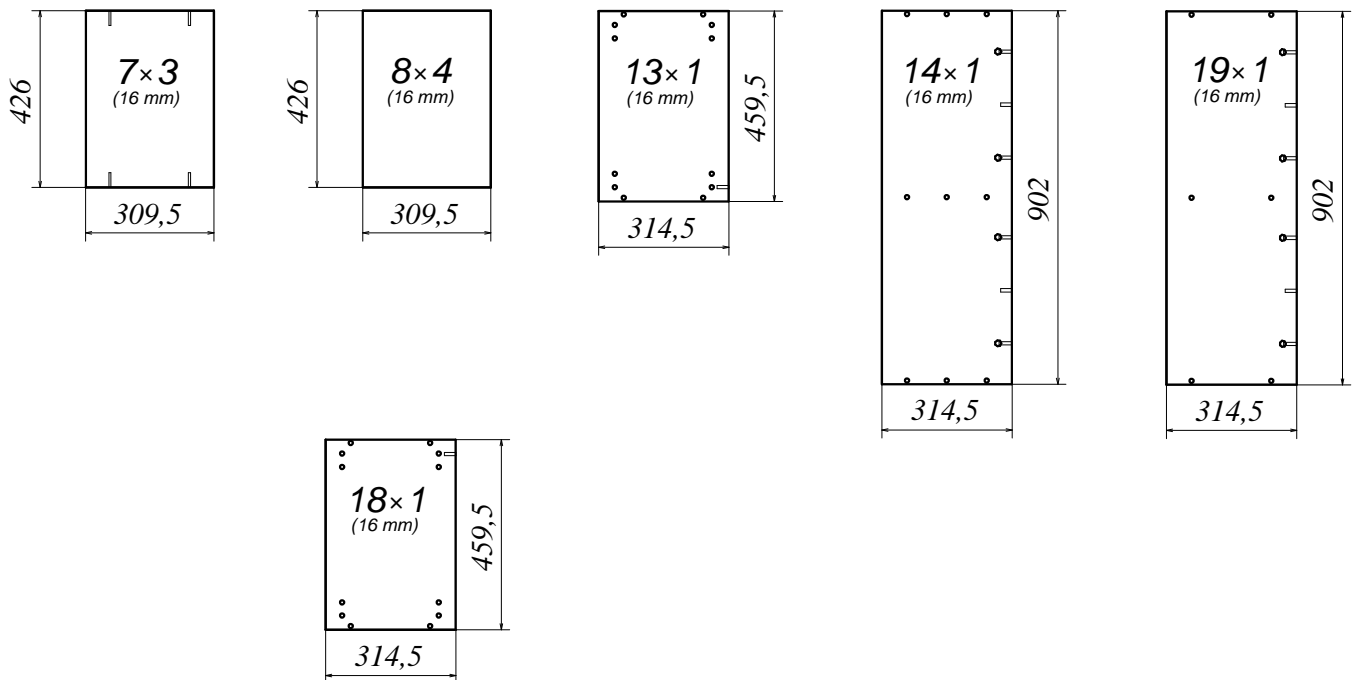

# Box 6/6

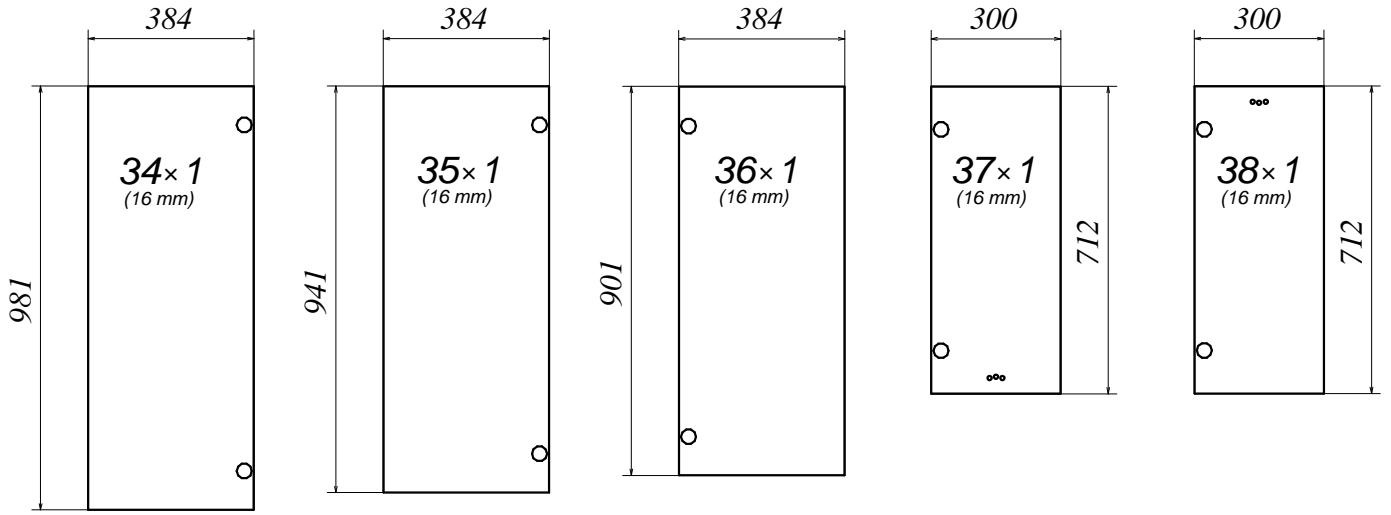

1

|   |   |   |   |   |  |  |  |  |
|---|---|---|---|---|--|--|--|--|
|  |  |  |  |  |  |  |  |  |
| ∅15x12 mm<br>B1 x 8   | ∅5x44 mm<br>B2 x 8  | ∅4x16 mm<br>D1 x 16   | ∅8x36 mm<br>G x 4   | M1 x 4  |  |  |  |  |

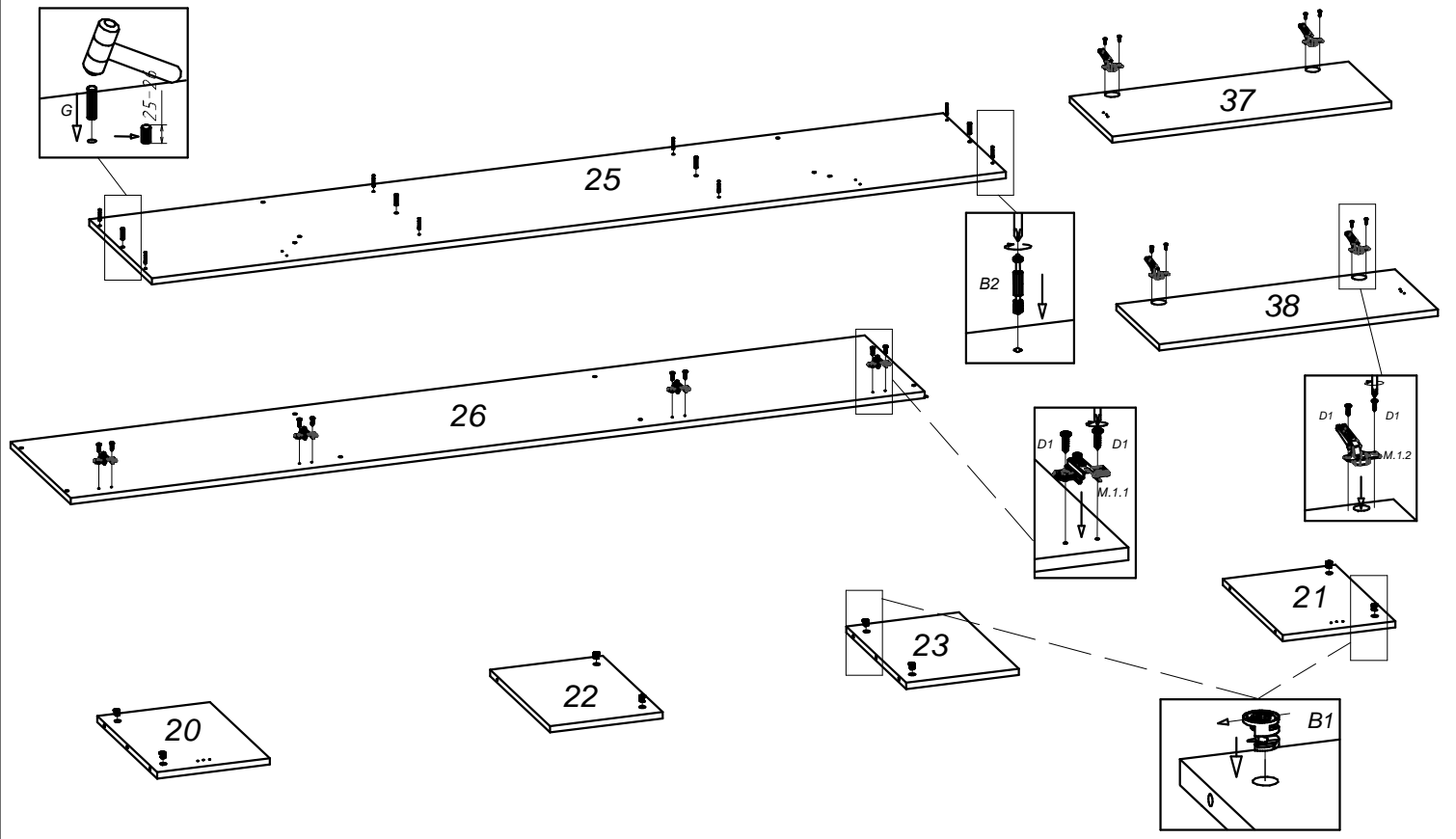



2

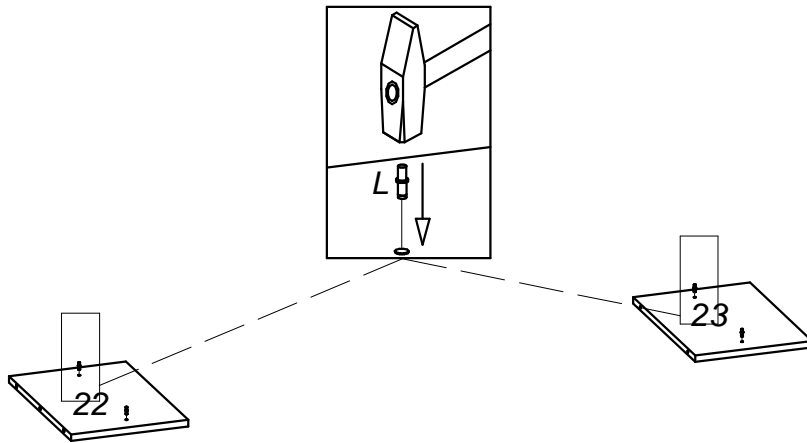

3

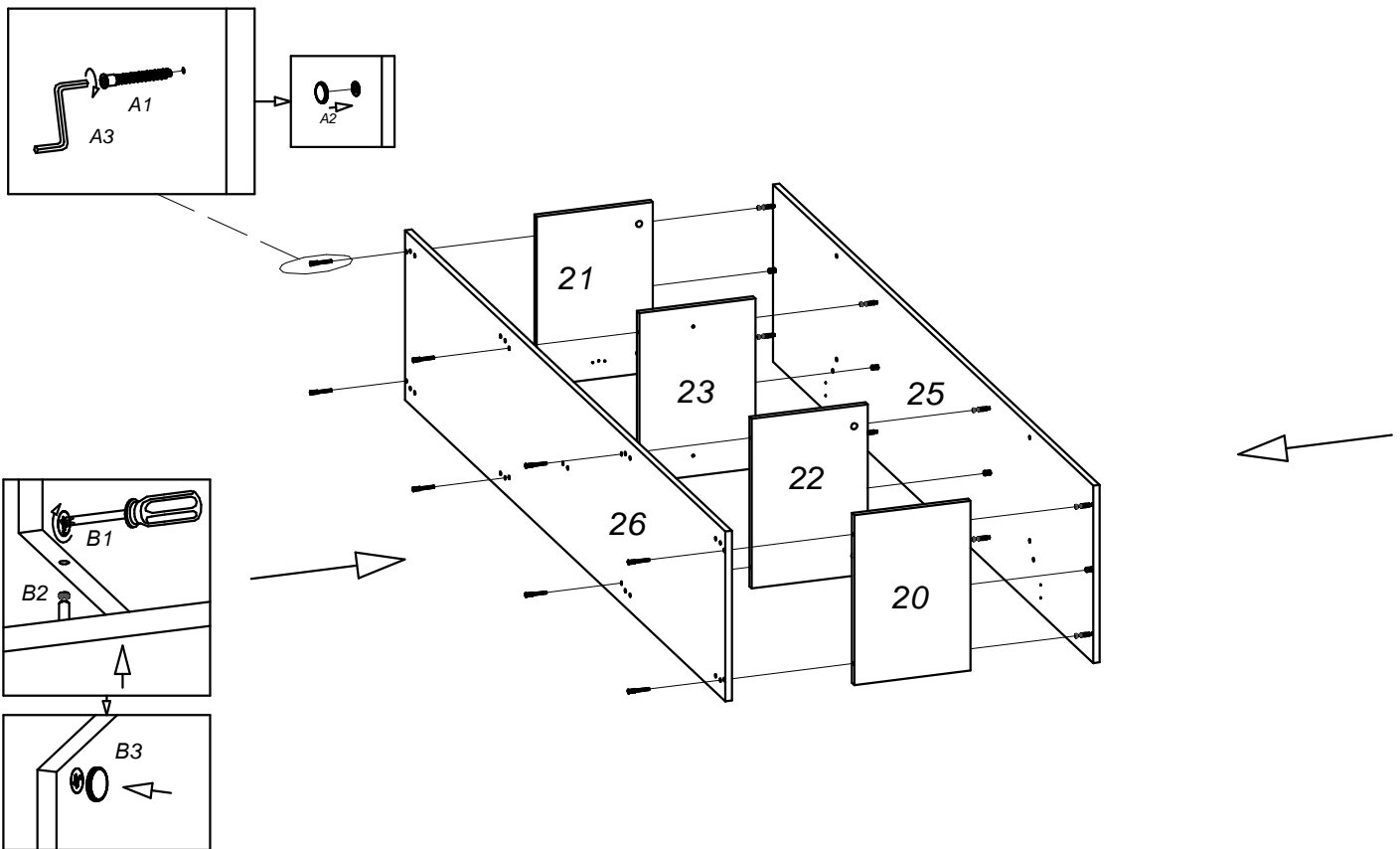
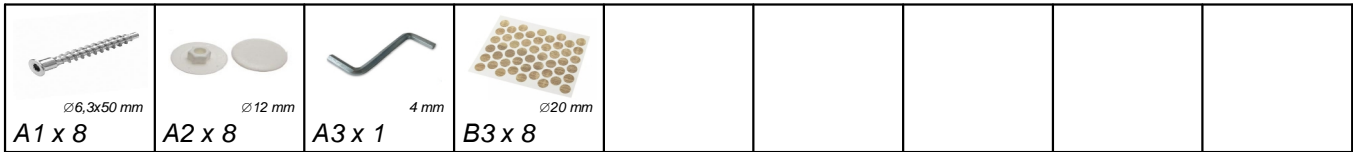

4



$$XX = YY = 90^\circ$$

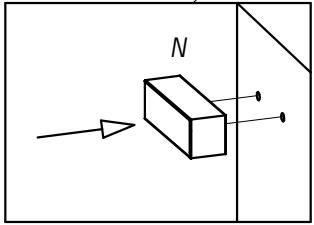
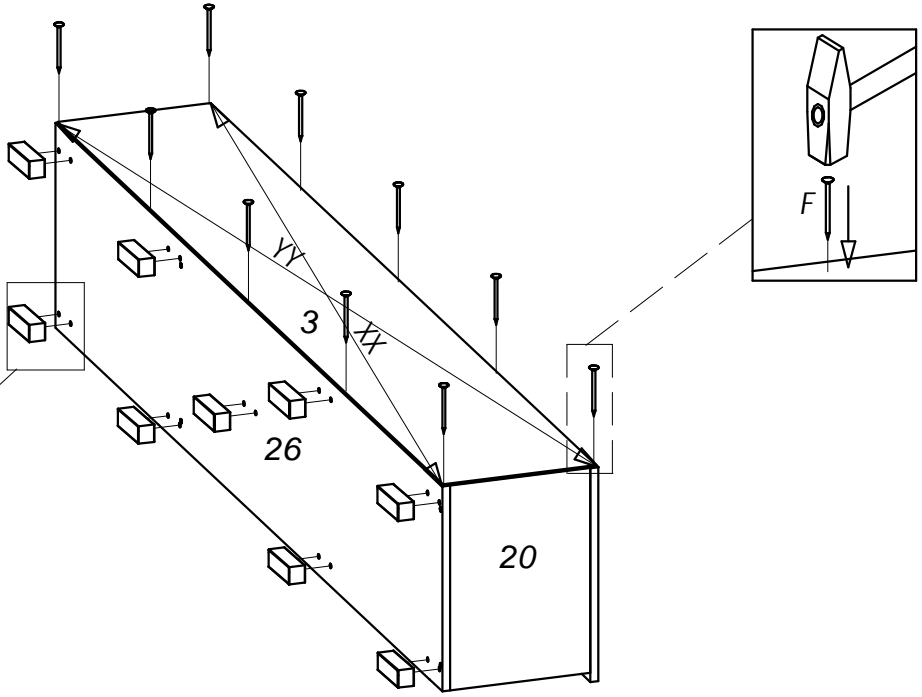

5

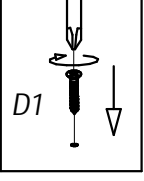
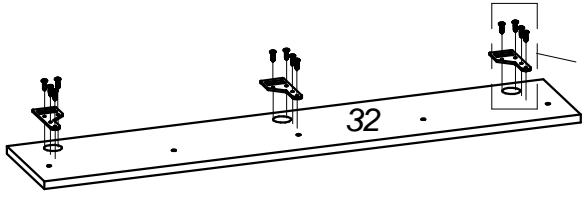
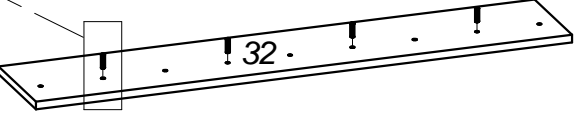
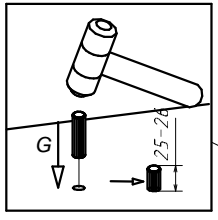

6

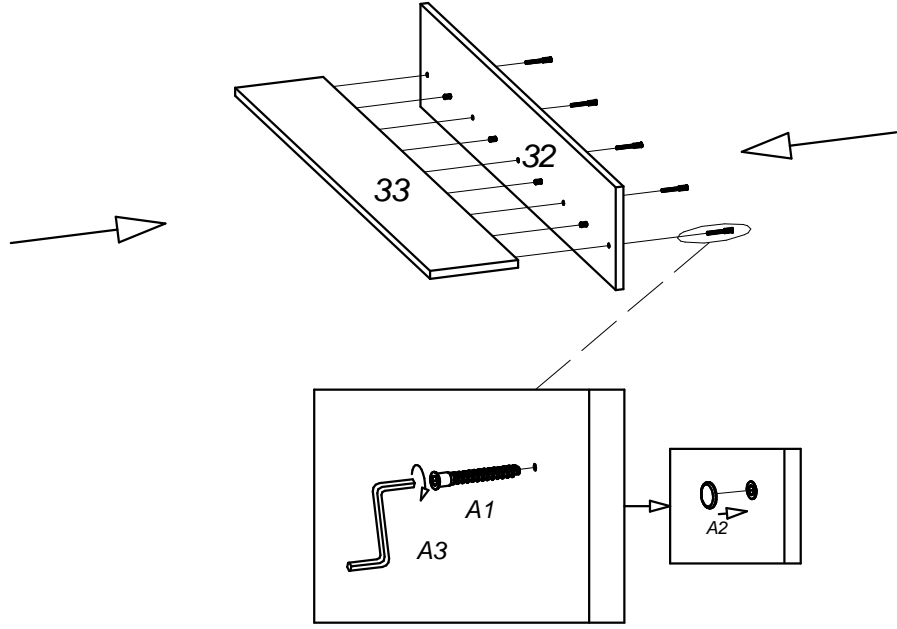
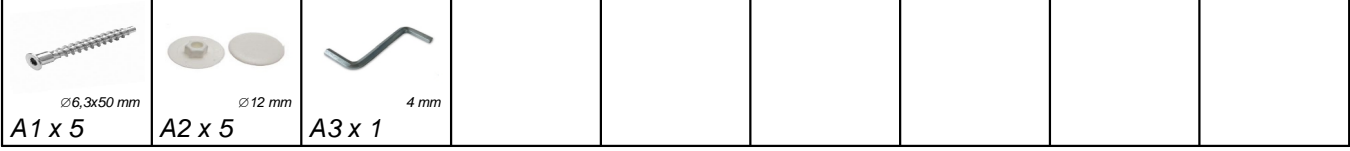

7

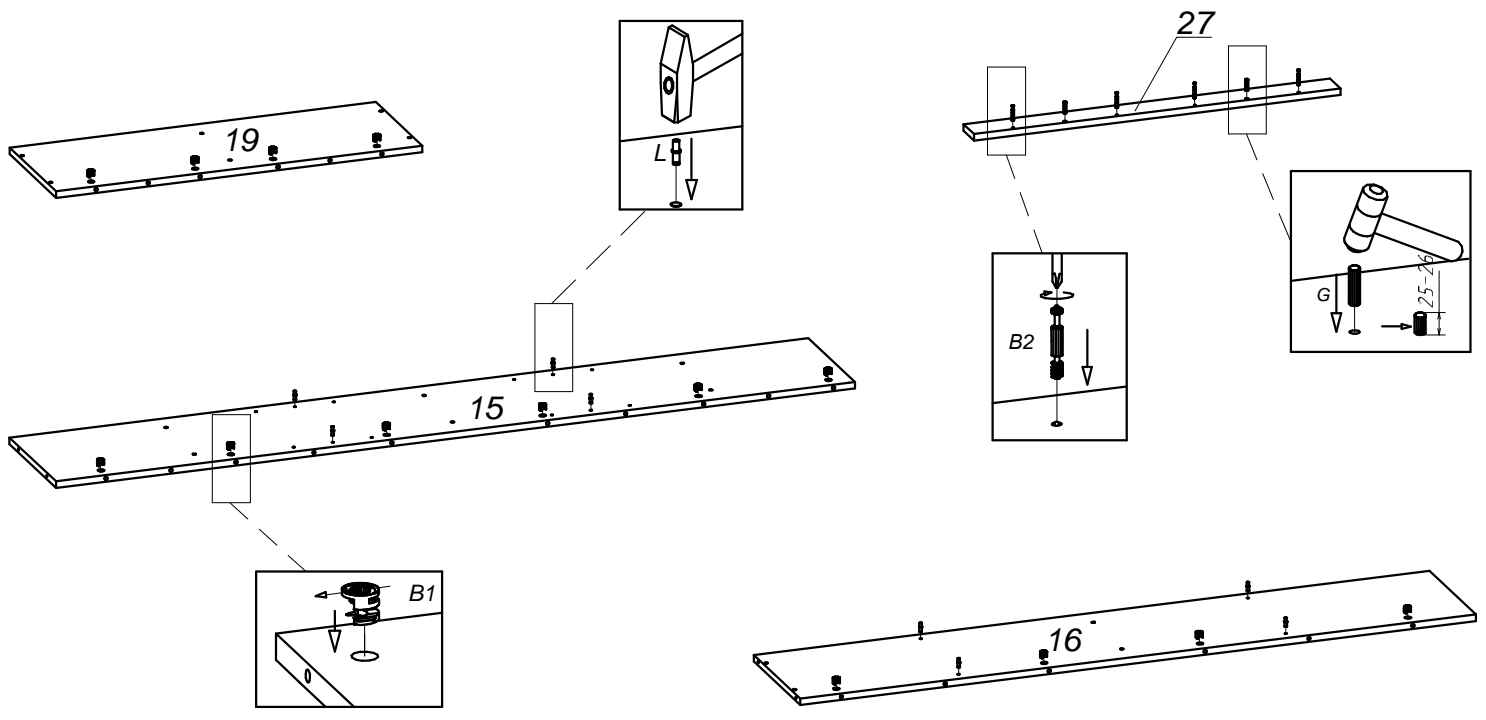
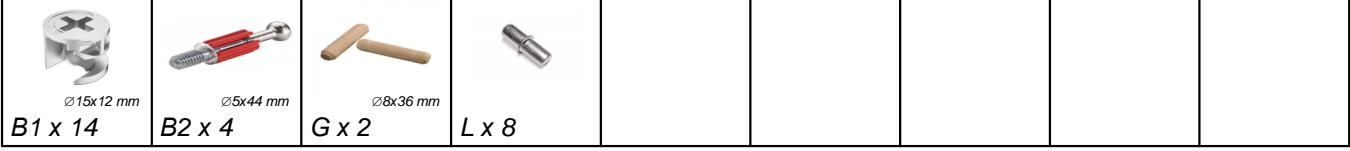

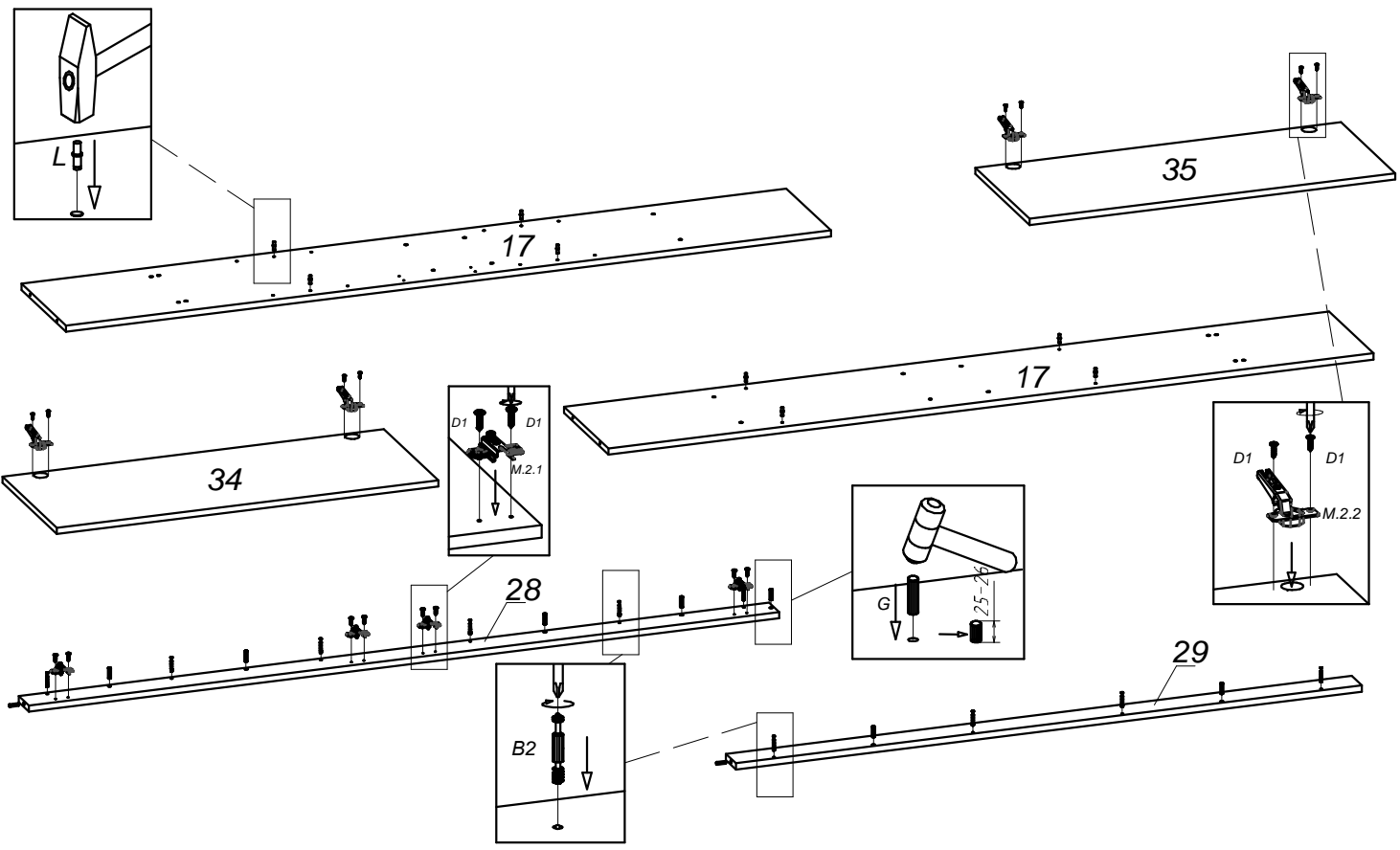

8

|   |   |   |   |  |  |  |  |  |  |
|---|---|---|---|--|--|--|--|--|--|
| <br>∅5x44 mm<br>B2 x 10 | <br>∅4x16 mm<br>D1 x 16 | <br>∅8x36 mm<br>G x 9 | <br>L x 8 | <br>M2 x 4 |  |  |  |  |  |
|---|---|---|---|--|--|--|--|--|--|



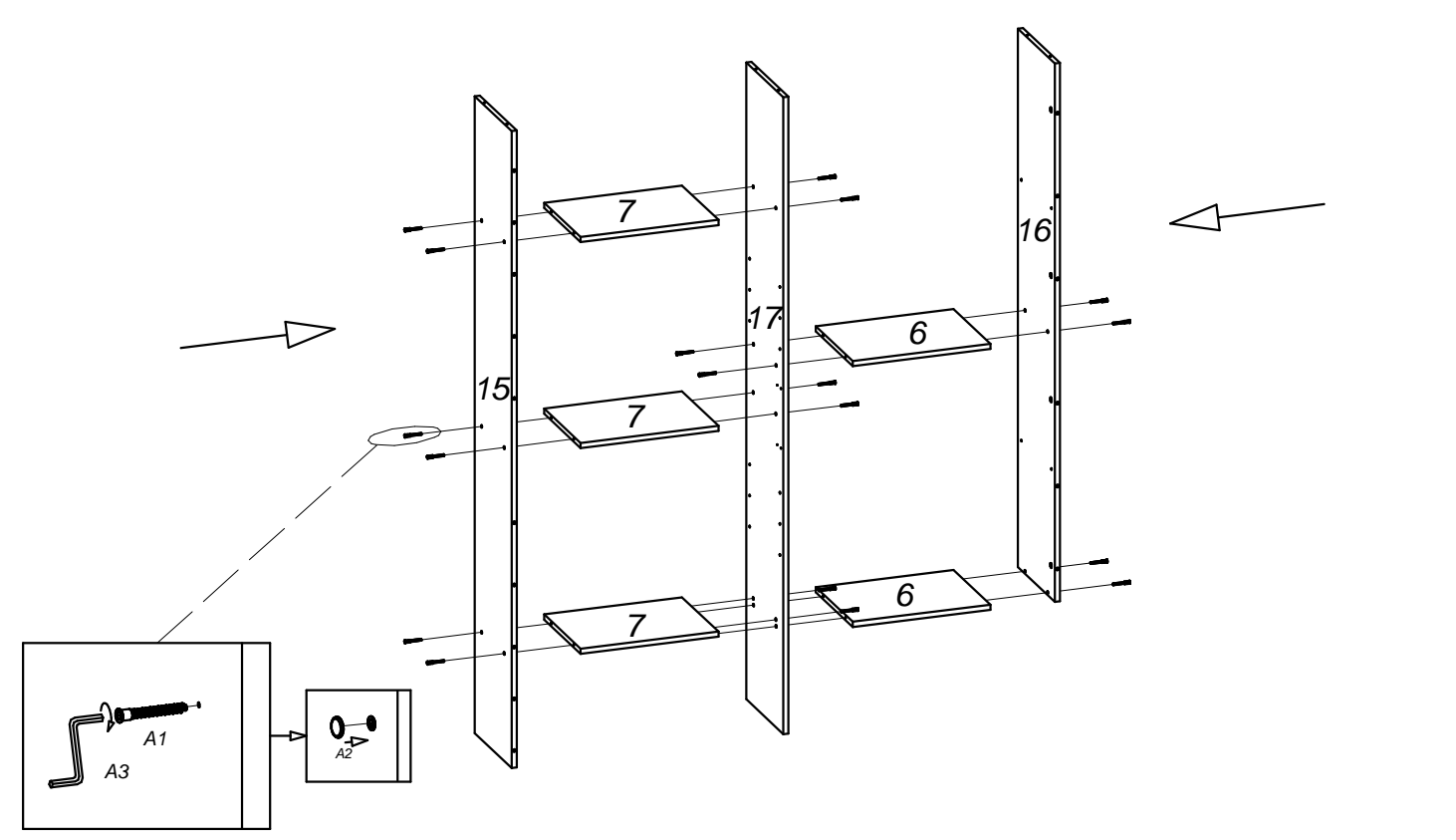

9

|  |  |   |  |  |  |  |  |  |  |
|--|--|---|--|--|--|--|--|--|--|
| <br>∅6,3x50 mm<br>A1 x 20 | <br>∅12 mm<br>A2 x 20 | <br>4 mm<br>A3 x 1 |  |  |  |  |  |  |  |
|--|--|---|--|--|--|--|--|--|--|



10

|   |   |  |  |  |  |  |  |  |  |
|---|---|--|--|--|--|--|--|--|--|
| <br>∅6,3x50 mm<br>A1 x 10 | <br>∅12 mm<br>A2 x 10 | <br>4 mm<br>A3 x 1 |  |  |  |  |  |  |  |
|---|---|--|--|--|--|--|--|--|--|

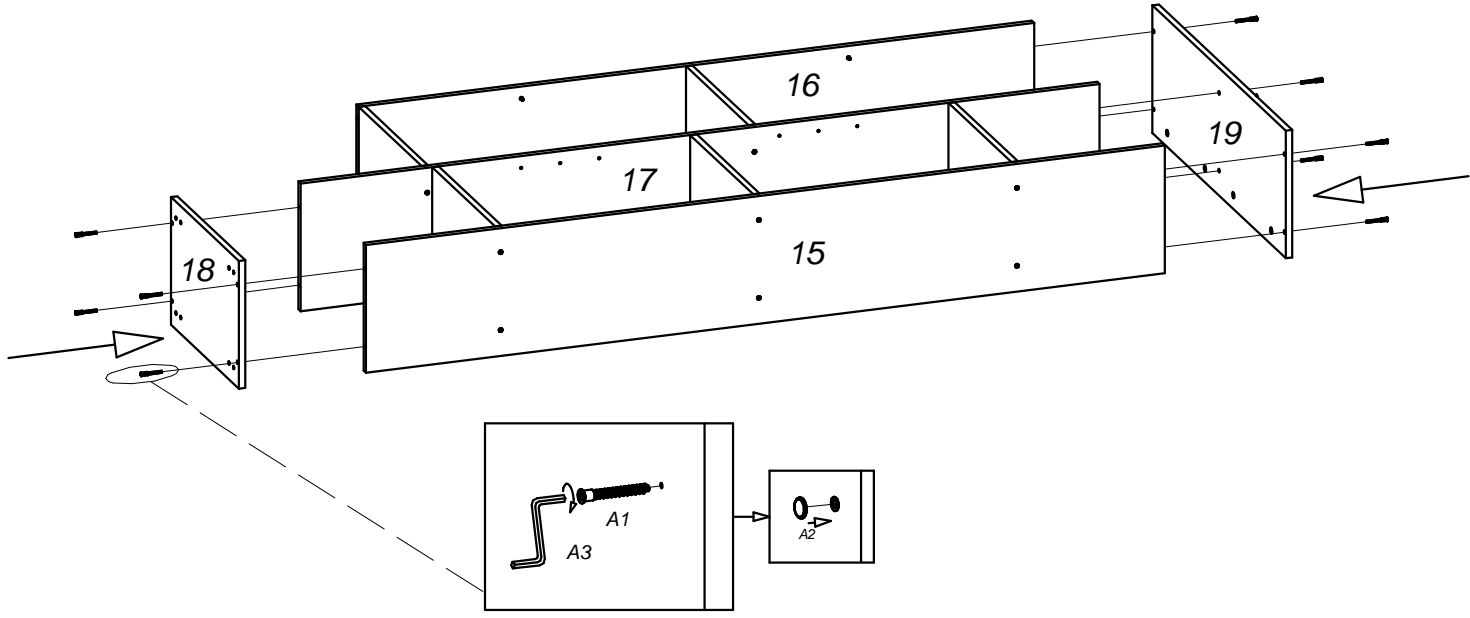

11

|  |  |  |  |  |  |  |  |  |  |
|--|--|--|--|--|--|--|--|--|--|
|  |  |  |  |  |  |  |  |  |  |
|--|--|--|--|--|--|--|--|--|--|

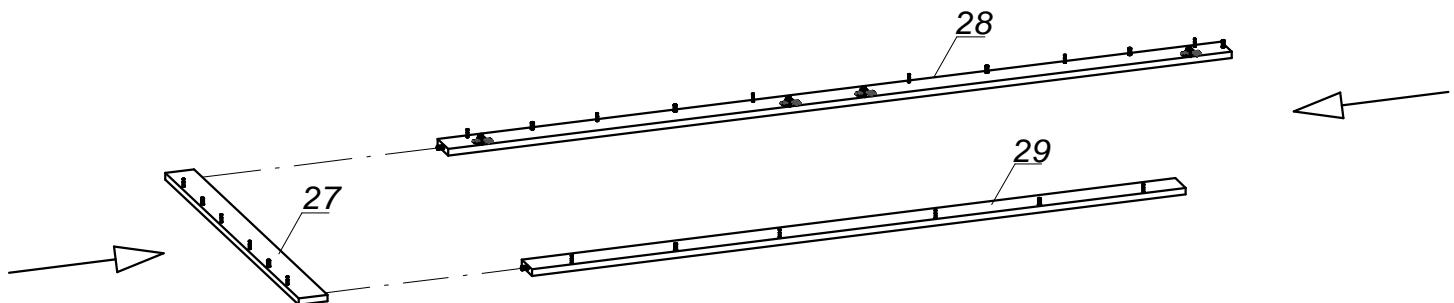

12

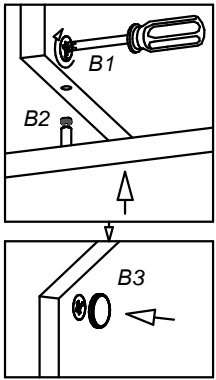
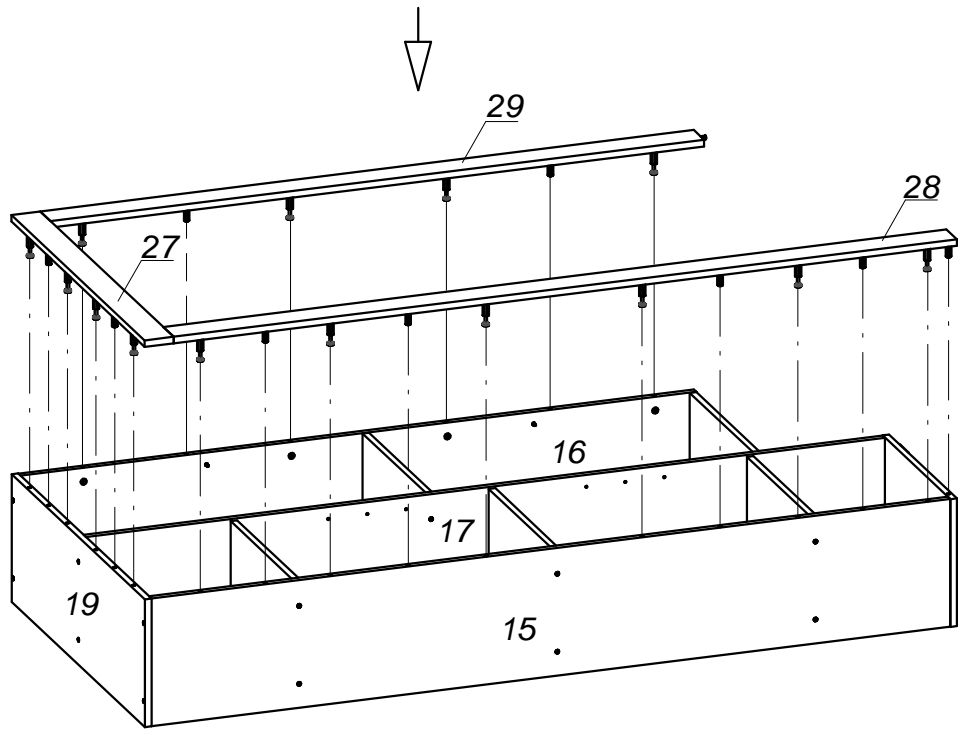
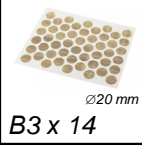

13

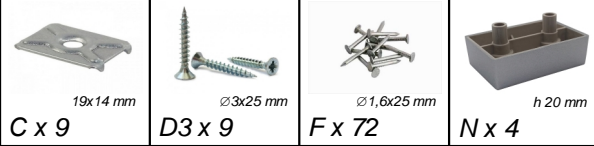

$XX=YY=90^\circ$

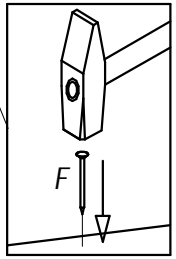
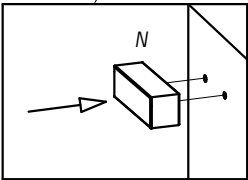
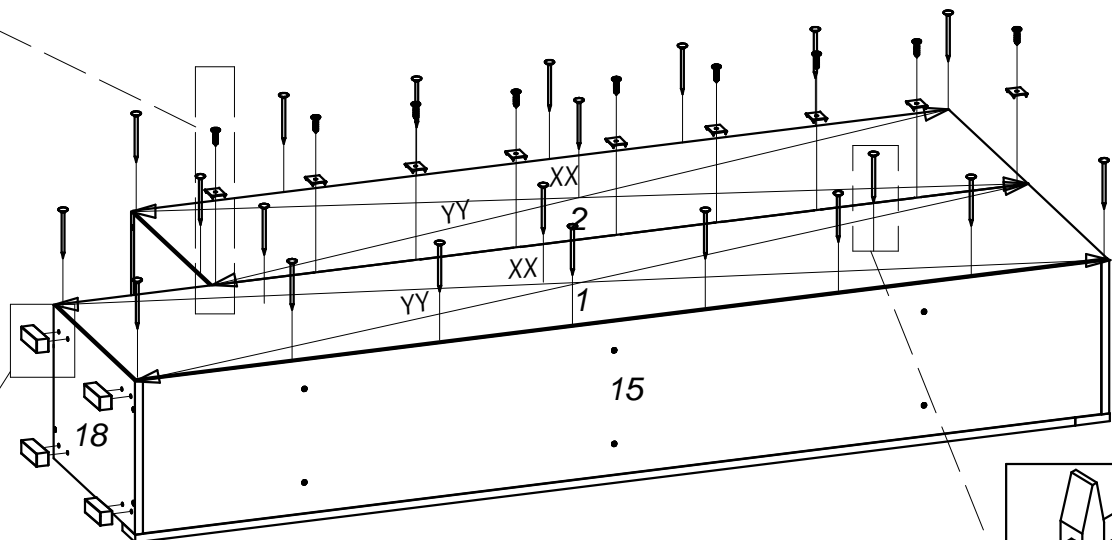
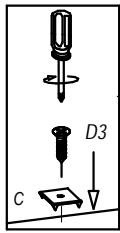

14

  
Ø15x12 mm  
B1 x 16

  
Ø5x44 mm  
B2 x 16

  
Ø4x16 mm  
D1 x 8



  
Ø8x36 mm  
G x 12

  
L x 12

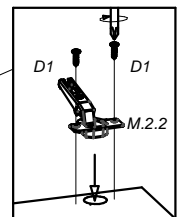
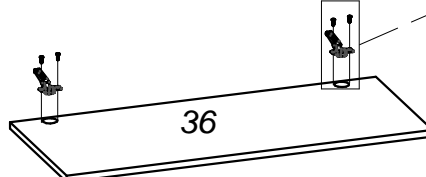
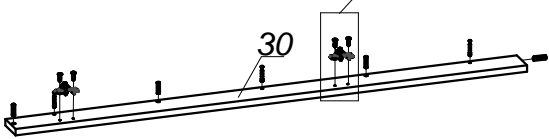
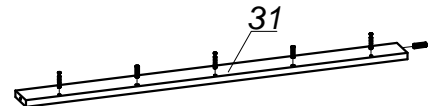
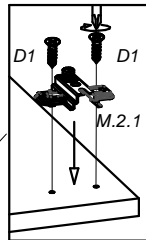
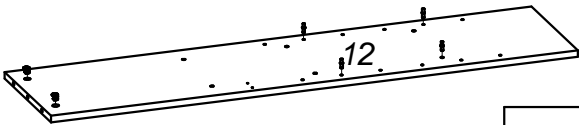
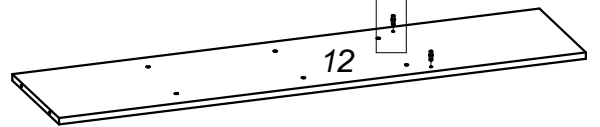
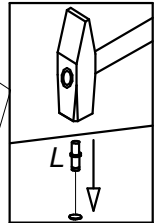
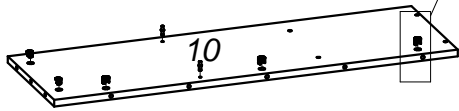
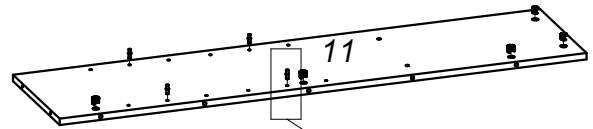
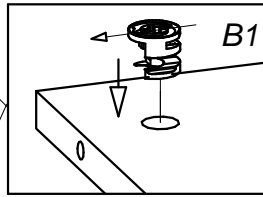
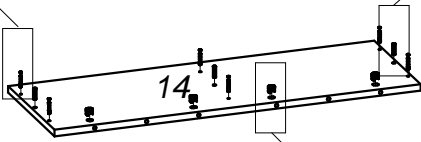
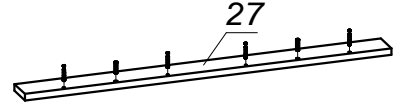
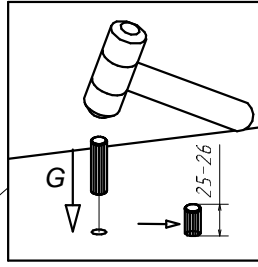
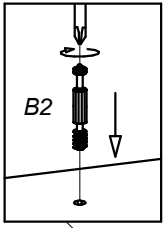
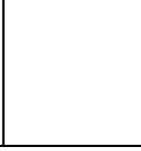
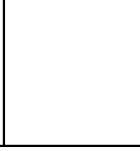
  
M2 x 2





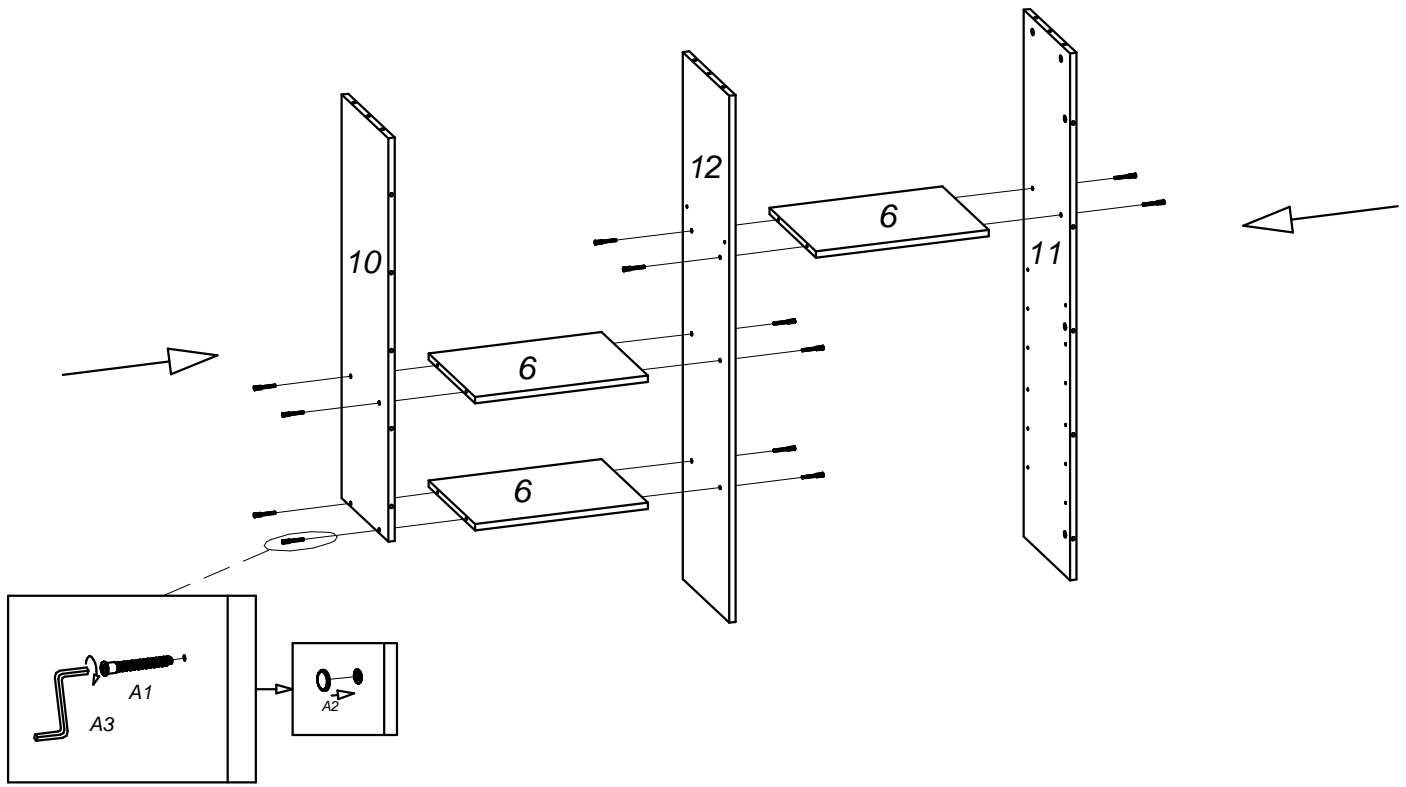

15

|   |   |  |  |  |  |  |  |  |  |
|---|---|--|--|--|--|--|--|--|--|
| <br>∅6,3x50 mm<br>A1 x 12 | <br>∅12 mm<br>A2 x 12 | <br>4 mm<br>A3 x 1 |  |  |  |  |  |  |  |
|---|---|--|--|--|--|--|--|--|--|



16

|   |   |   |   |  |  |  |  |  |  |
|---|---|---|---|--|--|--|--|--|--|
| <br>∅6,3x50 mm<br>A1 x 4 | <br>∅12 mm<br>A2 x 4 | <br>4 mm<br>A3 x 1 | <br>∅20 mm<br>B3 x 6 |  |  |  |  |  |  |
|---|---|---|---|--|--|--|--|--|--|

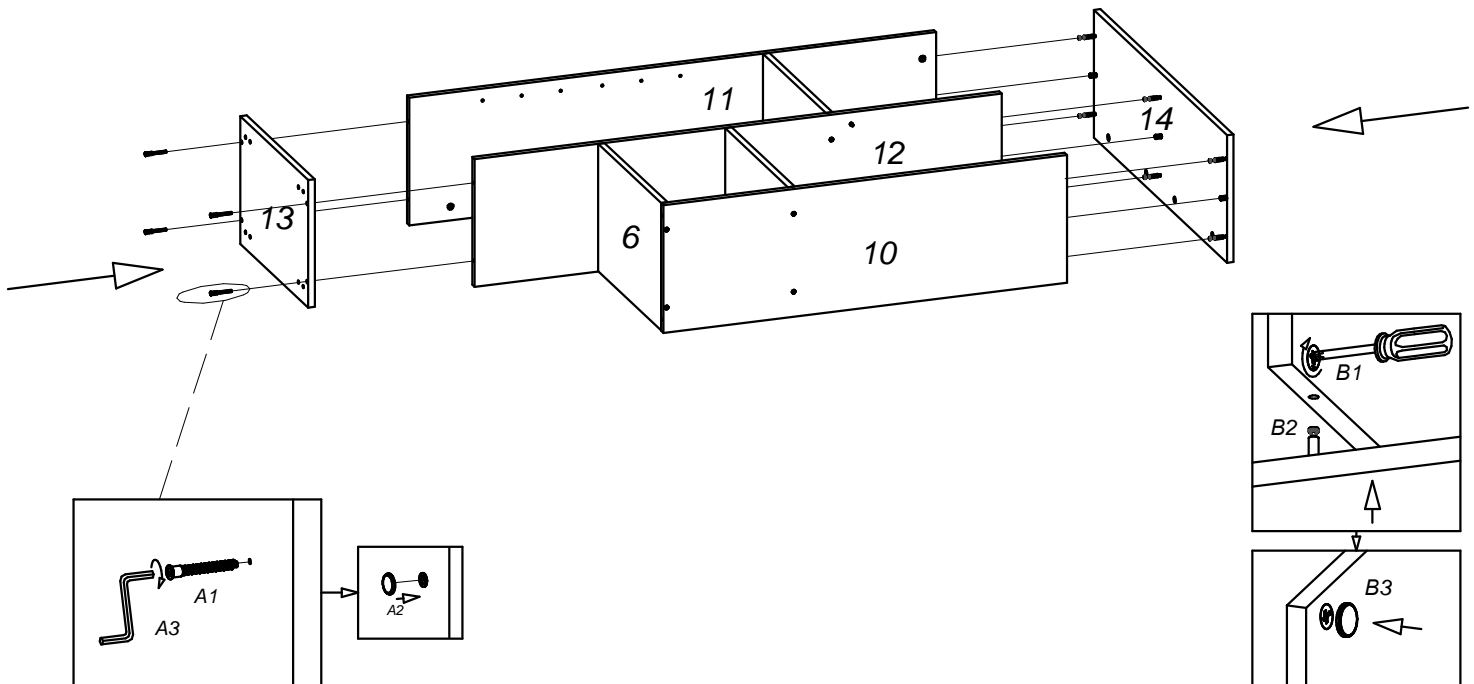



17

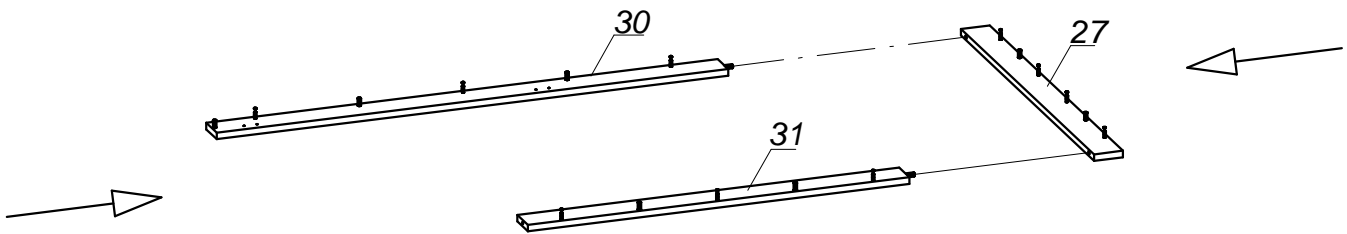
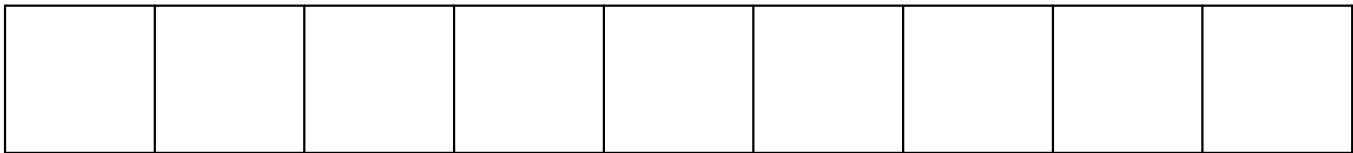

18

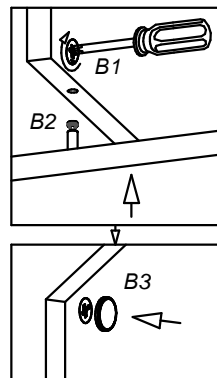
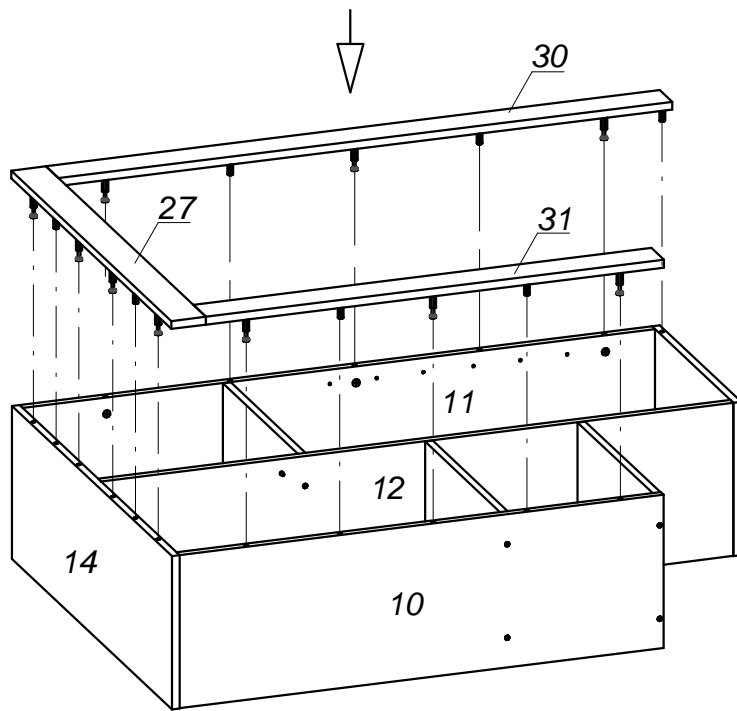
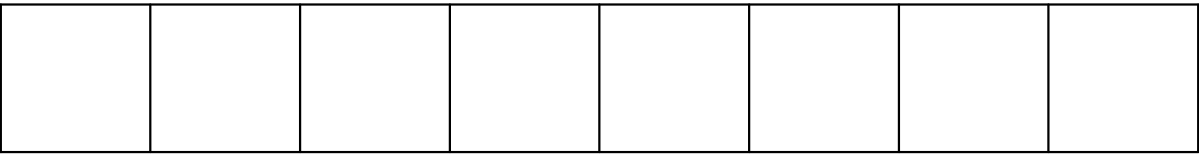
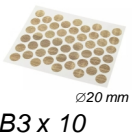

19

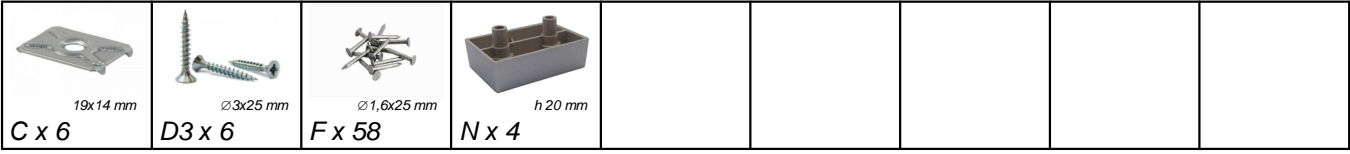

$XX=YY=90^\circ$

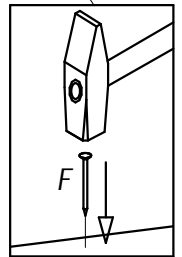
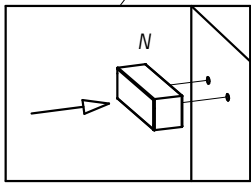
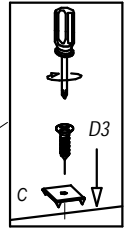
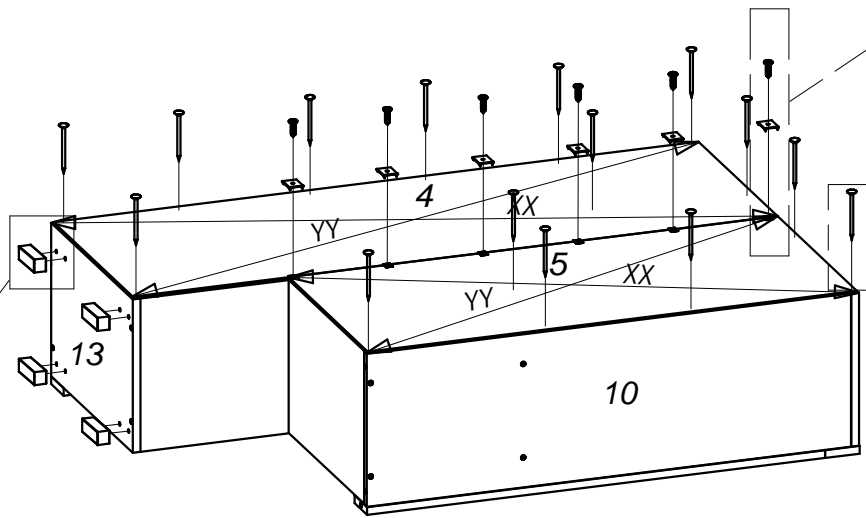

20

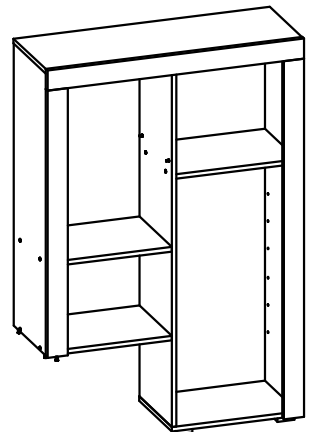
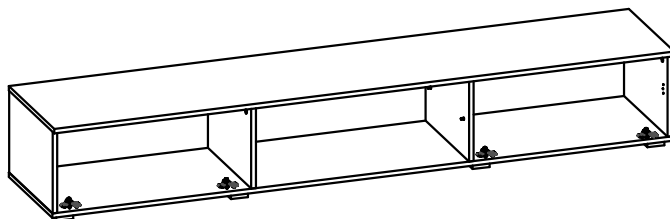
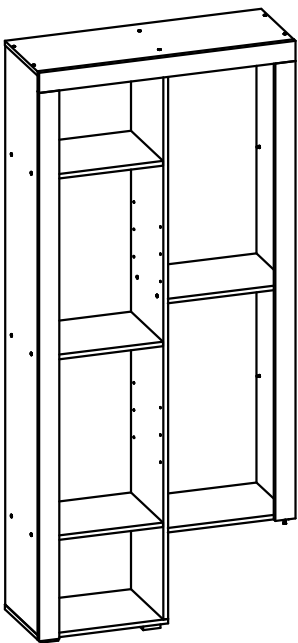
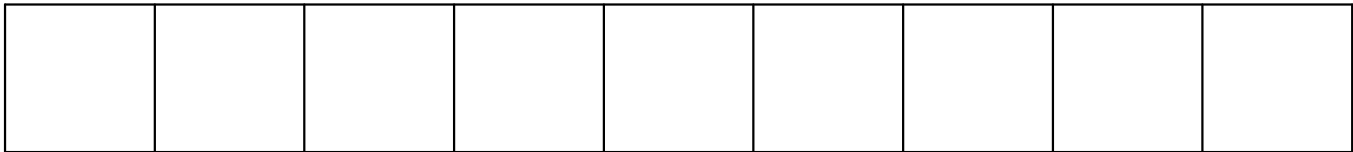

21

|  |  |  |  |   |  |  |  |  |
|--|--|--|--|---|--|--|--|--|
| <br>∅6,3x50 mm<br>A1 x 6 | <br>∅12 mm<br>A2 x 6 | <br>4 mm<br>A3 x 1 | <br>∅4x16 mm<br>D1 x 4 | <br>∅8x30 mm<br>T x 2 | <br>Y x 2 |  |  |  |
|--|--|--|--|---|--|--|--|--|

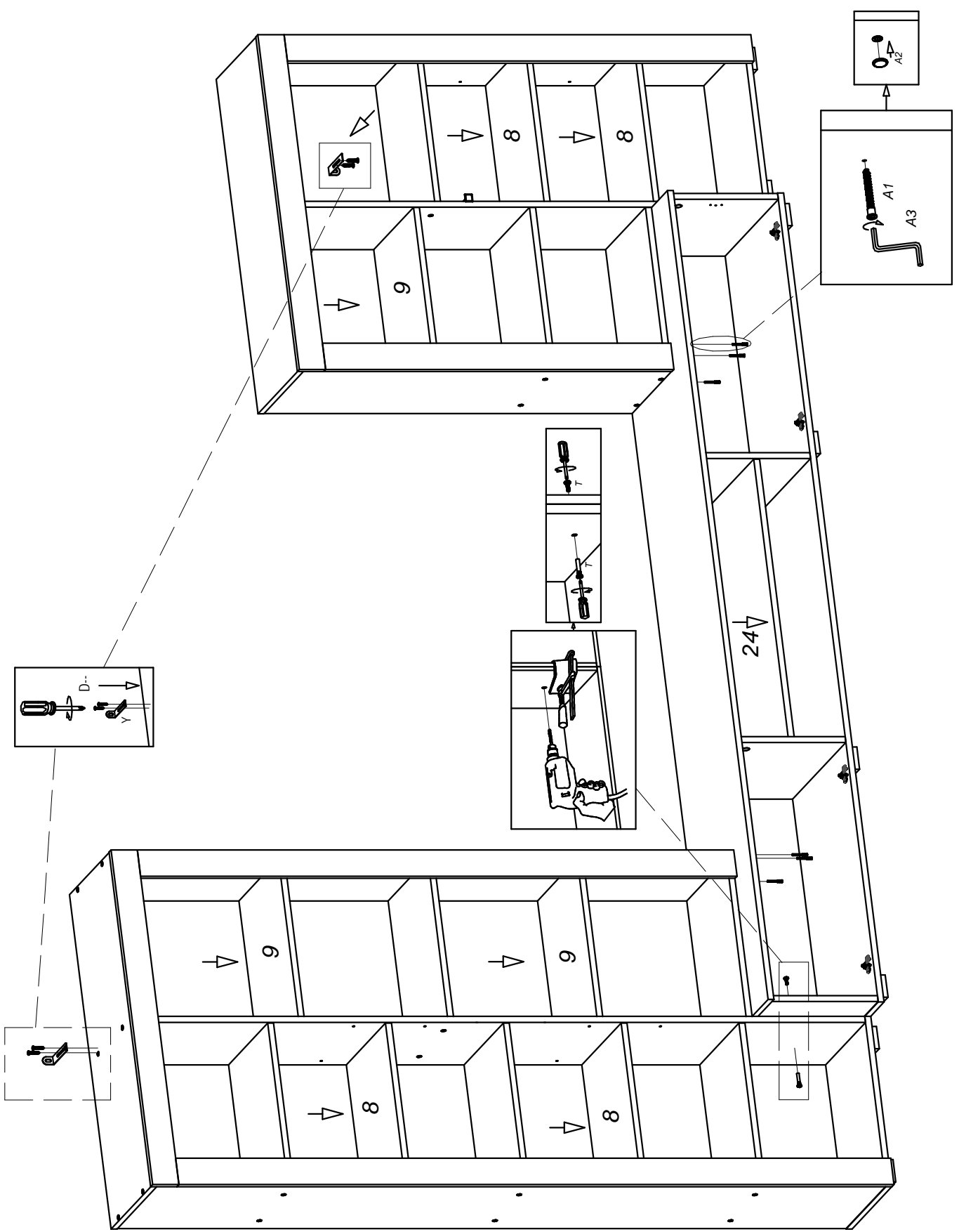

22

  
∅3x16 mm  
D2 x 10

  
V x 5

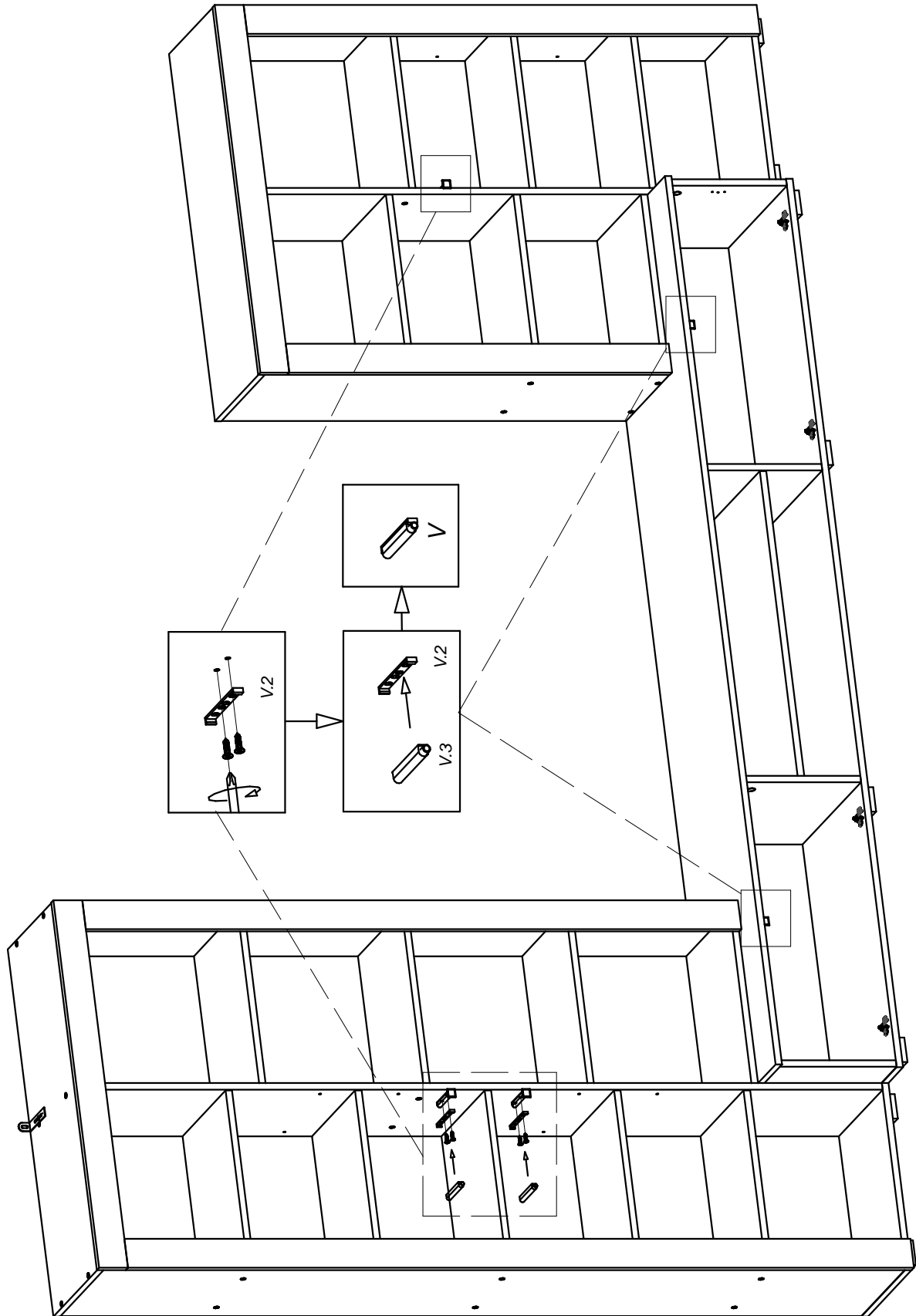

23

  
∅3x16 mm  
D2 x 12

  
X x 2

